

93

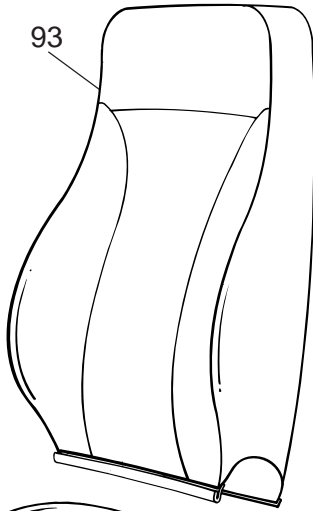

Sats 92  
Kit 92



91

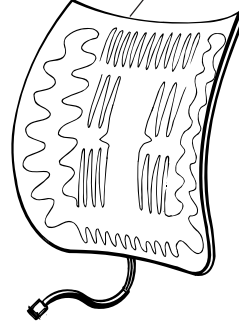

90

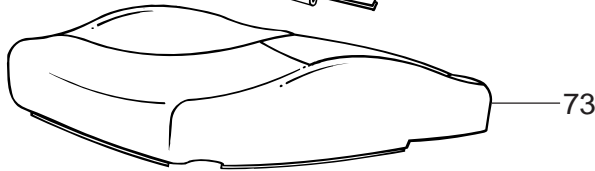
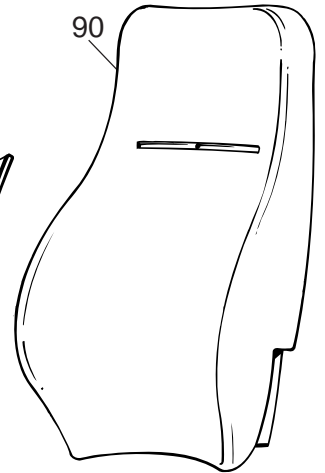

Sats 72  
Kit 72

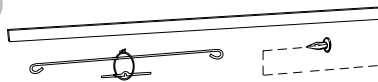

71

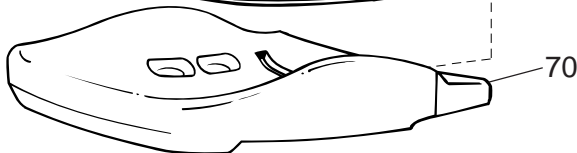

70

Sats 80  
Kit 80

83

82

81

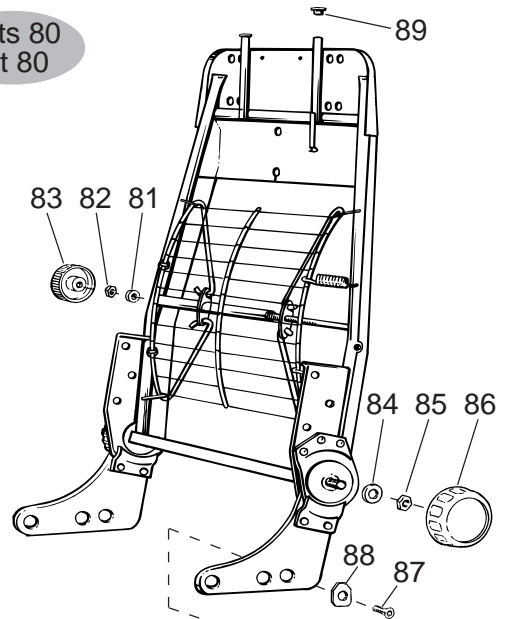

89

84

85

86

88

87

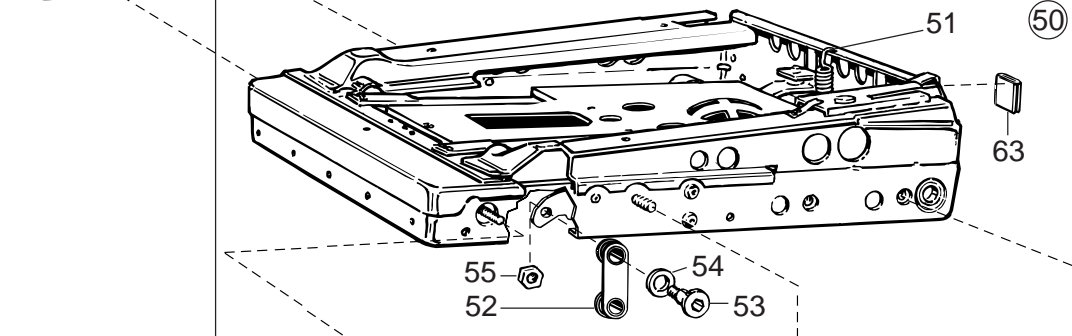
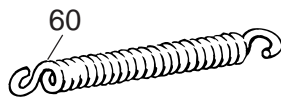
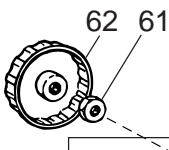
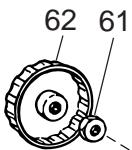

Sats 19  
Kit 19

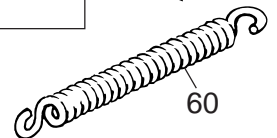
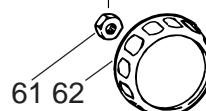
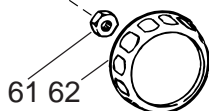



— Establ. 1934 —

Reservdelslista/Parts Replacement List

**BE-GE 9200** (Rygghöjd 640/Back height 640)

**BE-GE 9201** (Rygghöjd 550/Back height 550)

**BE-GE 9202** (Rygghöjd 400/Back height 400)

Dat./Date  
1998 03 01

Utgåva/Issue  
1

Sidan  
3 (5)

Pos Fig.	Art. nr. Part. No.	Antal Quantity		Benämning	Description
1	<b>500566</b>	1	•	<b>Glidskenor sats standard</b>	<b>Complete set of slides standard</b>
2	501212	1	••	Glidskena vänster standard	Slide rail left standard
3	501211	1	••	Glidskena höger standard	Slide rail right standard
4	500546	1	••	Bygel standard (uppbockad 45 mm)	Handle standard (bent 45 mm)
5	500302	4	••	Skruv MC6S M8x20 FZB 8.8	Bolt MC6S M8x20 FZB 8.8
6	652014	4	••	Bricka rund 8.4x21x4 FZB	Washer round 8.4x21x4 FZB
7	210425	4	••	Bricka FBB-B 8.1x14.8x2 FZB	Washer FBB-B 8.1x14.8x2 FZB
8	210400	4	••	Mutter M6M M8 FZB K8	Nut M6M M8 FZB K8
<b>15</b>	<b>500160</b>	1	•	<b>Skyddsbälg inkl. nit</b>	<b>Protection bellows incl. plastic rivets</b>
16	500214	17	••	Plastnit L=17.3 D=6.3	Plastic rivet L=17.3 D=6.3
17	500520	5	••	Plastnit	Plastic rivet
<b>19</b>	<b>620362</b>	1	•	<b>Underdel exkl. klädsel</b>	<b>Seat base exkl. covering</b>
20	500547	1	••	Bottenram	Bottom frame
25	620702	1	••	Sax komplett 1-stötd.	Scissors complete 1-shock absorber
26	501406	1	•••	Inre sax komplett	Scissors inner complete
27	620005	1	•••	Yttre sax komplett	Scissors outer complete
28	500115	2	•••	Länkarm nedre komplett standard	Lower slewing bracket compl. standard
29	621357	1	•••	Stötdämpare inkl. bussning, skruv m.m.	Shock absorber inkl. bushing, bolt etc.
30	620085	2	••••	Bussning stötdämpare	Bushing shock absorber
31	650045	2	••••	Skruv K6S M8x40 FZB 10.9	Bolt K6S M8x40 FZB 10.9
32	210401	2	••••	Mutter lås-helm. M8 FZB K8	Lock nut M8 FZB K8
37	500335	2	•••	Lagerbult saxcentrum mek-stol	Bearing bolt scissors centre mech. chair
38	620874	4	•••	Lagerbult (5 mm fläns)	Bearing bolt (5 mm flange)
39	500396	2	•••	Lagerbult (bakre övre lagring)	Bearing bolt (rear upper bearing)
40	500393	4	•••	Lagerbult (saxsystem)	Bearing bolt (scissors system)
41	500392	10	•••	Friktionsbricka	Washer
42	500413	10	•••	Mutter lås-helm. M10 FZB K8	Lock nut M10 FZB K8
50	620026	1	••	Sittram komplett dubbel tilt	Seat frame complete double tilttable
51	500128	1	•••	Dragfjäder för tvärstag	Tension spring for cross bar
52	620091	2	•••	Länkarm övre komplett	Slewing bracket upper complete
53	500393	2	•••	Lagerbult (saxsystem)	Bearing bolt (scissors system)
54	500392	2	•••	Friktionsbricka	Washer
55	500413	2	•••	Mutter lås-helm. M10 FZB K8	Lock nut M10 FZB K8
60	500127	2	••	Dragfjäder	Tension spring
61	210403	4	••	Mutter ML6M M10 FZB K5	Nut ML6M M10 FZB K5
62	500277	4	••	Ratt M10	Wheel M10
63	500304	1	••	Plastknopp höjdspar	Plastic knob height adjustment
<b>65</b>	<b>621318</b>	1	•	<b>Delrinbussningssats 9000 (stolens samtliga bussningar)</b>	<b>Bushing kit 9000 (all the seats bushings)</b>
<b>66</b>	<b>621319</b>	1	•	<b>Lagerbultsats 9000 (stolens samtliga lagerbultar inkl. muttrar)</b>	<b>Bearing bolt kit 9000 (all the seats bearing bolts incl. nuts)</b>
			•	= Huvudartikel	• = Head article
			••	= Ingår i föregående •	•• = Included in preceding •
			•••	= Ingår i föregående ••	••• = Included in preceding ••
			••••	= Ingår i föregående •••	•••• = Included in preceding •••





— Establ. 1934 —

Reservdelslista/Parts Replacement List

**BE-GE 9200** (Rygghöjd 640/Back height 640)**BE-GE 9201** (Rygghöjd 550/Back height 550)**BE-GE 9202** (Rygghöjd 400/Back height 400)Dat./Date  
1998 03 01Utgåva/Issue  
1Sidan  
4 (5)

Pos Fig.	Art. nr. Part. No.	Antal Quantity		Benämning	Description
70	500190	1	•	Skumdyna sits	Seat foam
70	500189	1	•	Skumdyna sits med tryckplatta (för stol med sitskontakt)	Seat foam with cushion contact plate (for seat with contact)
71	500349	1	•	Elvärmedyna sits 12V	Heating element seat cushion 12V
71	500357	1	•	Elvärmedyna sits 24V	Heating element seat cushion 24V
71	500567	1	•	Elvärmedyna sits 24V läderklädsel	Heating element seat cushion 12V leather covering
72	620780	1	•	Monteringsdetaljer sits TC	Assembly details seat TC
72	620916	1	•	Monteringsdetaljer sits plysch 82-89	Assembly details seat plush 82-89
72	620783	1	•	Monteringsdetaljer sits läder	Assembly details seat leather
73	640069	1	•	Klädsel sits TC pers-blå	Trim seat TC persian blue
73	640089	1	•	Klädsel sits TC röd	Trim seat TC red
73	640109	1	•	Klädsel sits TC brun	Trim seat TC brown
73	640129	1	•	Klädsel sits TC grafitgrå	Trim seat TC graphite grey
73	640149	1	•	Klädsel sits TC svart	Trim seat TC black
73	640315	1	•	Klädsel sits plysch blå 84	Trim seat plush blue 84
73	640275	1	•	Klädsel sits plysch röd 82	Trim seat plush red 82
73	640335	1	•	Klädsel sits plysch grå 89	Trim seat plush grey 89
73	640295	1	•	Klädsel sits plysch svart 83	Trim seat plush black 83
73	500958	1	•	Klädsel sits konstläder grå	Trim seat leather imitation grey
73	500586	1	•	Klädsel sits läder arizona grå	Trim seat leather arizona grey
80	500285	1	•	Ryggram 640	Back rest 640
80	620108	1	•	Ryggram 550	Back rest 550
80	500647	1	•	Ryggram 400	Back rest 400
81	500268	1	••	Bricka SRB 9x18x1.5 SV.KR	Plain washer SRB 9x18x1.5 SV.KR
82	651011	1	••	Mutter M6M M8 SV.KR K8	Nut M6M M8 SV.KR K8
83	500279	1	••	Ratt svankstöd	Wheel lumbar support
84	310366	2	••	Plastbricka 22.6x10.2x3.5	Plastic washer 22.6x10.2x3.5
85	210403	2	••	Mutter ML6M M10 FZB K5	Nut ML6M M10 FZB K5
86	500277	2	••	Ratt M10	Wheel M10
87	310930	4	••	Skruv MF6S M8x20 SV.KR 10.9	Bolt MF6S M8x20 SV.KR 10.9
88	620143	1	••	Excenterbricka	Excenterwasher
89	500385	2	••	Nackstödshylsa svart	Head rest sleeve black
90	500191	1	•	Skumdyna rygg 640	Back foam 640
90	500192	1	•	Skumdyna rygg 550	Back foam 550
90	620116	1	•	Skumdyna rygg 400	Back foam 400
91	500350	1	•	Elvärmedyna rygg 12V	Heating element back 12V
91	500358	1	•	Elvärmedyna rygg 24V	Heating element back 24V
91	500568	1	•	Elvärmedyna rygg 24V läderklädsel	Heating element back 24V leather covering
			•	= Huvudartikel	= Head article
			••	= Ingår i föregående •	= Included in preceding •
			•••	= Ingår i föregående ••	= Included in preceding ••
			••••	= Ingår i föregående •••	= Included in preceding •••





— Establ. 1934 —

Reservdelslista/Parts Replacement List

**BE-GE 9200** (Rygghöjd 640/Back height 640)**BE-GE 9201** (Rygghöjd 550/Back height 550)**BE-GE 9202** (Rygghöjd 400/Back height 400)Dat./Date  
1998 03 01Utgåva/Issue  
1Sidan  
5 (5)

Pos Fig.	Art. nr. Part. No.	Antal Quantity		Benämning	Description
92	620786	1	•	Monteringsdetaljer rygg 640, 550 TC	Assembly details back 640, 550 TC
92	620919	1	•	Monteringsdetaljer rygg 640, 550 plysch 82-89	Assembly details back 640, 550 plush 82-89
92	620787	1	•	Monteringsdetaljer rygg 640, 550, 400 läder	Assembly details back 640, 550, 400 leather
92	—	0	•	Monteringsdetaljer rygg 400 TC	Assembly details back 400 TC
92	—	0	•	Monteringsdetaljer rygg 400 plysch 82-89	Assembly details back 400 plush 82-89
93	640066	1	•	Klädsel rygg 640 TC pers-blå	Trim back 640 TC persian blue
93	640086	1	•	Klädsel rygg 640 TC röd	Trim back 640 TC red
93	640106	1	•	Klädsel rygg 640 TC brun	Trim back 640 TC brown
93	640126	1	•	Klädsel rygg 640 TC grafitgrå	Trim back 640 TC graphite grey
93	640146	1	•	Klädsel rygg 640 TC svart	Trim back 640 TC black
93	640312	1	•	Klädsel rygg 640 plysch blå 84	Trim back 640 plush blue 84
93	640272	1	•	Klädsel rygg 640 plysch röd 82	Trim back 640 plush red 82
93	640332	1	•	Klädsel rygg 640 plysch grå 89	Trim back 640 plush grey 89
93	640292	1	•	Klädsel rygg 640 plysch svart 83	Trim back 640 plush black 83
93	500951	1	•	Klädsel rygg 640 konstläder grå	Trim back 640 leather imitation grey
93	500596	1	•	Klädsel rygg 640 läder arizona grå	Trim back 640 leather arizona grey
93	640067	1	•	Klädsel rygg 550 TC pers-blå	Trim back 550 TC persian blue
93	640087	1	•	Klädsel rygg 550 TC röd	Trim back 550 TC red
93	640107	1	•	Klädsel rygg 550 TC brun	Trim back 550 TC brown
93	640127	1	•	Klädsel rygg 550 TC grafitgrå	Trim back 550 TC graphite grey
93	640147	1	•	Klädsel rygg 550 TC svart	Trim back 550 TC black
93	640313	1	•	Klädsel rygg 550 plysch blå 84	Trim back 550 plush blue 84
93	640273	1	•	Klädsel rygg 550 plysch röd 82	Trim back 550 plush red 82
93	640333	1	•	Klädsel rygg 550 plysch grå 89	Trim back 550 plush grey 89
93	640293	1	•	Klädsel rygg 550 plysch svart 83	Trim back 550 plush black 83
93	500953	1	•	Klädsel rygg 550 konstläder grå	Trim back 550 leather imitation grey
93	640044	1	•	Klädsel rygg 550 läder arizona grå	Trim back 640 leather arizona grey
93	640068	1	•	Klädsel rygg 400 TC pers-blå	Trim back 400 TC persian blue
93	640088	1	•	Klädsel rygg 400 TC röd	Trim back 400 TC red
93	640108	1	•	Klädsel rygg 400 TC brun	Trim back 400 TC brown
93	640128	1	•	Klädsel rygg 400 TC grafitgrå	Trim back 400 TC graphite grey
93	640148	1	•	Klädsel rygg 400 TC svart	Trim back 400 TC black
93	640314	1	•	Klädsel rygg 400 plysch blå 84	Trim back 400 plush blue 84
93	640274	1	•	Klädsel rygg 400 plysch röd 82	Trim back 400 plush red 82
93	640334	1	•	Klädsel rygg 400 plysch grå 89	Trim back 400 plush grey 89
93	640294	1	•	Klädsel rygg 400 plysch svart 83	Trim back 400 plush black 83
93	500955	1	•	Klädsel rygg 400 konstläder grå	Trim back 400 leather imitation grey
93	640045	1	•	Klädsel rygg 400 läder arizona grå	Trim back 400 leather grey
			•	= Huvudartikel	= Head article
			••	= Ingår i föregående •	= Included in preceding •
			•••	= Ingår i föregående ••	= Included in preceding ••
			••••	= Ingår i föregående •••	= Included in preceding •••

